

Top<sup>®</sup>  
Light

# LIGHT FOR LIVING

2021/2022



Design by<sup>®</sup>

R  
Z  
Raif Ziel

# SYSTEM

- |                                      |           |
|--------------------------------------|-----------|
| 1. Mini Track                        | 294 - 307 |
| 2. Top Line: Ceiling, Gallery, Crown | 308 - 341 |
| 3. Eutrac                            | 342 - 347 |

Perfekt zugeschnitten auf jede Art der Illumination sind unsere Leuchtensysteme. Auch anspruchsvolle architektonische Bereiche lassen sich optimal ausleuchten. Dabei kann jeder nach Lust und Laune seinen Geschmack ausleben. Auch lange Flure oder schwierige Ecken lassen sich mit den Schienensystemen leicht überbrücken. Modernste LED Technologie hält dabei die Kosten in Grenzen. Wahlweise sind aber auch Modelle mit Halogenfassung erhältlich.

Our luminaire systems are perfectly tailored to every type of illumination. Even challenging architectural areas can be optimally illuminated. Everyone can live out his or her taste according to desire and taste.. Even long corridors or difficult corners can be easily illuminated with the track systems. State-of-the-art LED technology keeps costs within limits. Models with halogen sockets are also available.







# SYSTEMLEUCHTEN SYSTEM LAMPS

## 1. Mini Track 292 - 307



Puk Mini Turn 299



Puk Mini Eye 299



Puk Mini Side Single 199  
Puk Mini Side Twin 301



Puk Mini Long One 301  
Puk Maxx Long One 301



Puk Mini Drop 302  
Puk Maxx Drop 302



Puk Mini Flex 302



Look at me 303



Pela (Quadro) 303



Sun Ceiling 304



Sun Swing 304/305



Glaslight 305/306  
Spotlight 306



Neo 307

## 2. Top Line 308 - 341



Top Line Ceiling  
310 - 319



Top Line Gallery  
324 - 329



Top Line Crown  
330 - 329



Sun Swing 321



Pela (Quadro) 322



Look at me 323

## 3. Eutrac 342 - 347



Puk Mini Turn 343  
Puk Maxx Turn 345



Puk Mini Eye 343  
Puk Maxx Eye 345



Puk Mini Side 343  
Puk Maxx Side 345



Puk Mini Flex 343



Puk Maxx Next 345



Puk Mini Long One 343  
Puk Maxx Long One 345



Puk Mini Drop 343  
Puk Maxx Drop 345



Allround 347

# MINI TRACK Components Overview

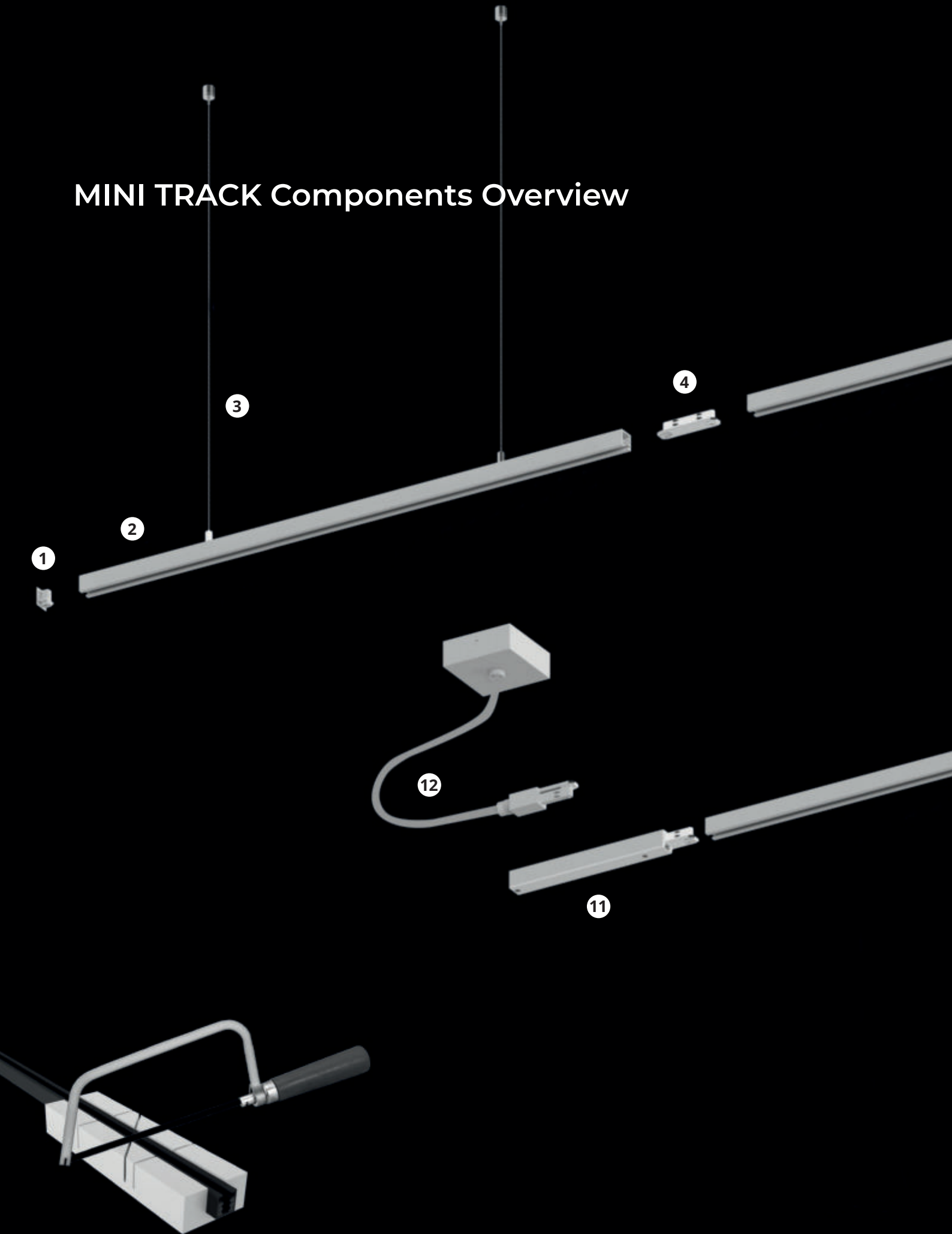

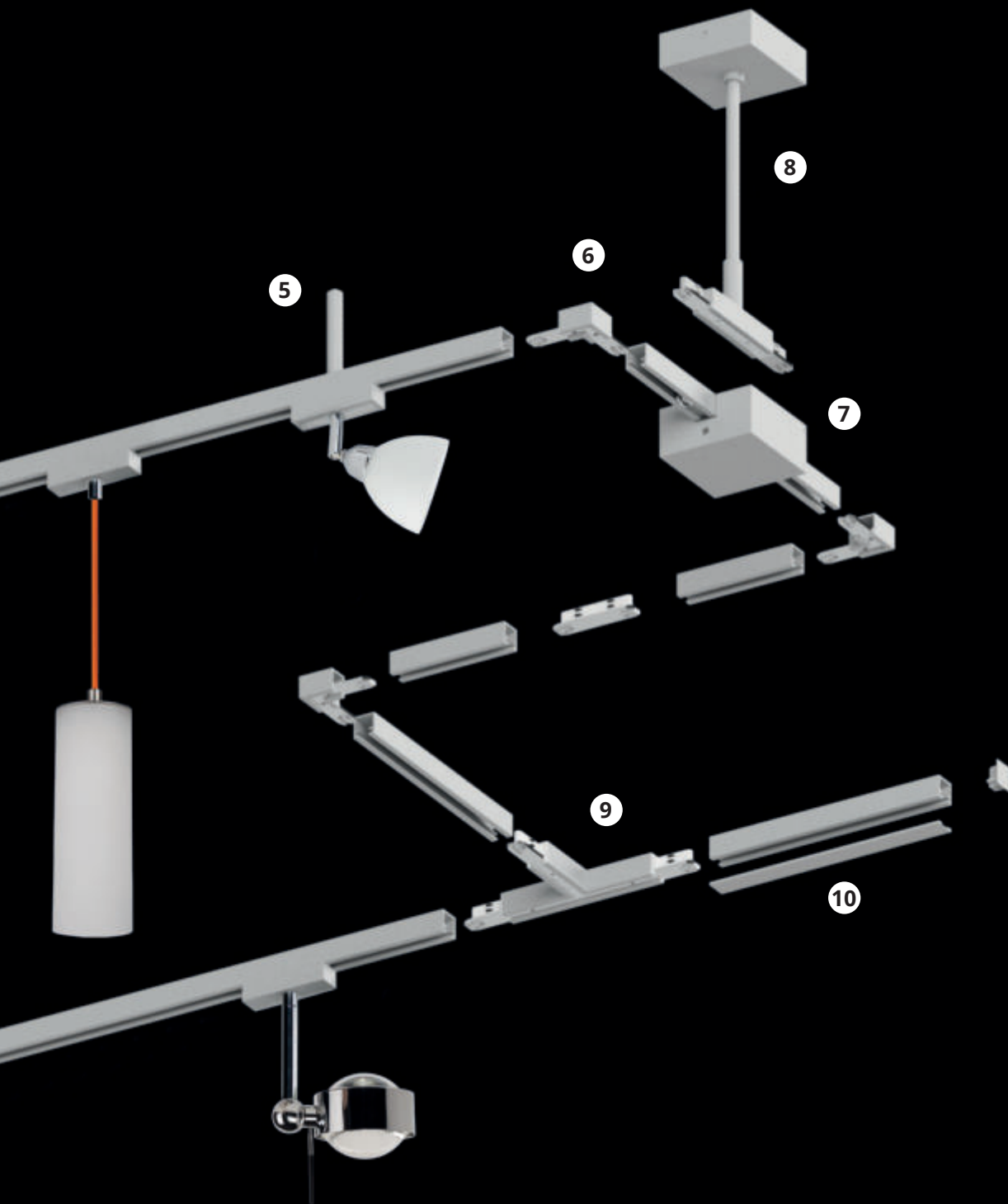

- ① Endkappe / End piece
- ② Profil besonders klein 18 x 18 mm / Profile very small 18 x 18 mm
- ③ Seilabhängung / Steel cable suspension
- ④ Linearverbinder / Linear junction
- ⑤ Deckenbefestigung / Surface mounting
- ⑥ 90° Winkelverbinder / T-Connection
- ⑦ Mitteleinspeisung mit Baldachin / Centre power feed with canopy
- ⑧ Kabelmitteleinspeisung mit Baldachin / Centre cable power feed with canopy
- ⑨ T-Verbinder / T-Connection
- ⑩ Blindabdeckung / Aluminium cover
- ⑪ Endeinspeisung / End power feed
- ⑫ Kabelendeinspeisung mit Baldachin / Cable end power feed with canopy



Art Nr	Farbe	Beschreibung Mini Track	L mm	B mm	H mm
33-102-cr	chrom	2 Phasen Schiene	1000	18	18
33-102-w	weiß	2 Phasen Schiene	1000	18	18
33-102-b	schwarz	2 Phasen Schiene	1000	18	18
33-102-s	natur eloxiert	2 Phasen Schiene	1000	18	18
33-103-cr	chrom	2 Phasen Schiene	2000	18	18
33-103-w	weiß	2 Phasen Schiene	2000	18	18
33-103-b	schwarz	2 Phasen Schiene	2000	18	18
33-103-s	natur eloxiert	2 Phasen Schiene	2000	18	18
33-104-w	weiß	2 Phasen Schiene	2950	18	18
33-104-b	schwarz	2 Phasen Schiene	2950	18	18
33-104-s	natur eloxiert	2 Phasen Schiene	2950	18	18

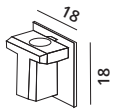

33-105-s	natur eloxiert-silber	Endkappe Schiene	18	18	18
33-105-w	weiß	Endkappe Schiene	18	18	18
33-105-b	schwarz	Endkappe Schiene	18	18	18

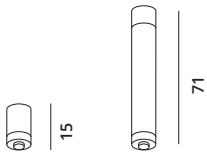

33-106-cr	chrom	Deckenbefestigung	12	12	15
33-106-w	weiß	Deckenbefestigung	12	12	15
33-106-b	schwarz	Deckenbefestigung	12	12	15
33-106-s	natur eloxiert	Deckenbefestigung	12	12	15
33-107-cr	chrom	Deckenbefestigung	12	12	71
33-107-w	weiß	Deckenbefestigung	12	12	71
33-107-b	schwarz	Deckenbefestigung	12	12	71
33-107-s	natur eloxiert	Deckenbefestigung	12	12	71

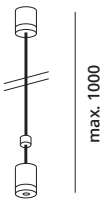

33-108-cr	chrom	Seilabhängung	13	13	1000
33-108-w	weiß	Seilabhängung	13	13	1000
33-108-b	schwarz	Seilabhängung	13	13	1000
33-108-s	natur eloxiert	Seilabhängung	13	13	1000

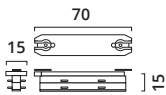

33-109-cr	chrom	Linearverbinder	70	15	15
-----------	-------	-----------------	----	----	----

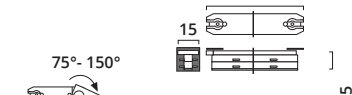

33-110-cr	chrom	Isolierverbinder	70	15	15
-----------	-------	------------------	----	----	----

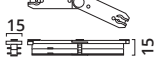

33-111-cr	chrom	Flex-Verbinder 75-150°	110	15	15
-----------	-------	------------------------	-----	----	----

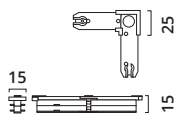

33-112-cr	chrom	Winkelverbinder 90°	25	15	15
33-112-w	weiß	Winkelverbinder 90°	25	15	15
33-112-b	schwarz	Winkelverbinder 90°	25	15	15
33-112-s	natur eloxiert	Winkelverbinder 90°	25	15	15

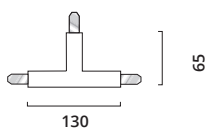

33-113-cr	chrom	T-Verbinder	130	65	18
33-113-w	weiß	T-Verbinder	130	65	18
33-113-b	schwarz	T-Verbinder	130	65	18
33-113-s	natur eloxiert	T-Verbinder	130	65	18

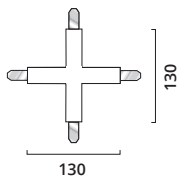

33-114-cr	chrom	Kreuzverbinder	130	130	18
33-114-w	weiß	Kreuzverbinder	130	130	18
33-114-b	schwarz	Kreuzverbinder	130	130	18
33-114-s	natur eloxiert	Kreuzverbinder	130	130	18



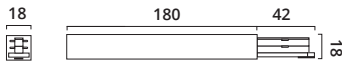

TL Art Nr	Farbe	Beschreibung MINI TRACK	L mm	B mm	H mm
33-115-cr	chrom	Endeinspeisung	180	18	18
33-115-w	weiß	Endeinspeisung	180	18	18
33-115-b	schwarz	Endeinspeisung	180	18	18
33-115-s	natur eloxiert	Endeinspeisung	180	18	18

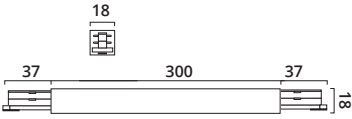

33-116-cr	chrom	Mitteinspeisung	300	18	18
33-116-w	weiß	Mitteinspeisung	300	18	18
33-116-b	schwarz	Mitteinspeisung	300	18	18
33-116-s	natur eloxiert	Mitteinspeisung	300	18	18

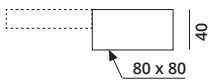

33-117-cr	chrom	Endeinspeisung Baldachin	80	80	40
33-117-w	weiß	Endeinspeisung Baldachin	80	80	40
33-117-b	schwarz	Endeinspeisung Baldachin	80	80	40
33-117-s	natur eloxiert	Endeinspeisung Baldachin	80	80	40

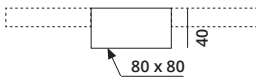

33-118-cr	chrom	Mitteinspeisung Baldachin	80	80	40
33-118-w	weiß	Mitteinspeisung Baldachin	80	80	40
33-118-b	schwarz	Mitteinspeisung Baldachin	80	80	40
33-118-s	natur eloxiert	Mitteinspeisung Baldachin	80	80	40

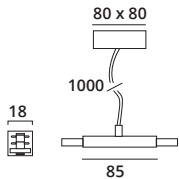

33-119-cr	chrom	Kabelmitteleinspeisung	80	80	1000
33-119-w	weiß	Kabelmitteleinspeisung	80	80	1000
33-119-b	schwarz	Kabelmitteleinspeisung	80	80	1000
33-119-s	natur eloxiert	Kabelmitteleinspeisung	80	80	1000

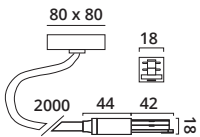

33-120-cr	chrom	Kabelendeinsp. Baldachin	80	80	2000
33-120-w	weiß	Kabelendeinsp. Baldachin	80	80	2000
33-120-b	schwarz	Kabelendeinsp. Baldachin	80	80	2000
33-120-s	natur eloxiert	Kabelendeinsp. Baldachin	80	80	2000

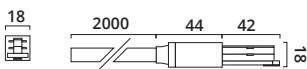

33-121-cr	chrom	Kabelendeinsp.o.Baldachin	18	18	2000
33-121-w	weiß	Kabelendeinsp.o.Baldachin	18	18	2000
33-121-b	schwarz	Kabelendeinsp.o.Baldachin	18	18	2000
33-121-s	natur eloxiert	Kabelendeinsp.o.Baldachin	18	18	2000



33-122-cr	chrom	Adapter für Hängeleuchten	71	18	34
33-122-s	natur eloxiert-silber	Adapter für Hängeleuchten	71	18	34
33-122-w	weiß	Adapter für Hängeleuchten	71	18	34
33-122-b	schwarz	Adapter für Hängeleuchten	71	18	34

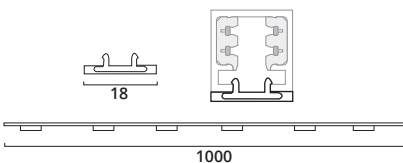

33-123-cr	chrom	Blindabdeckung	1000	18	3
33-123-w	weiß	Blindabdeckung	1000	18	3
33-123-b	schwarz	Blindabdeckung	1000	18	3
33-123-s	natur eloxiert	Blindabdeckung	1000	18	3





**PUK TURN**  
DOWNLIGHT



**PUK EYE CEILING**  
UP & DOWNLIGHT



**PUK SIDE SINGLE**  
UP & DOWNLIGHT

Adapterfarben: für chrommatt = silber, für chrom = chrom, für weiß/chrom = weiß und für schwarz/chrom = schwarz  
 Adapter Color: for chrom matt = silver, for chrome = chrome, for white/chrome = white and for black/chrome = black



SYSTEM

□ Chrom Teile/  
chrome parts  
■ Gepulverte Teile/  
powdered parts

**Puk Turn**

LED **G**

Lumen: ~600

Kelvin: ~2.700

Watt: 1 x 8W

📏 : Ø 80mm X H 97mm

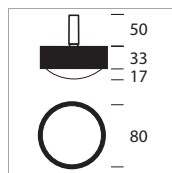

□ Chrom Teile/  
chrome parts  
■ Gepulverte Teile/  
powdered parts

**Puk Eye Ceiling**

LED **G**

Lumen: ~1.200

Kelvin: ~2.700

Watt: 2 x 8W

📏 : Ø 80mm X H 170mm

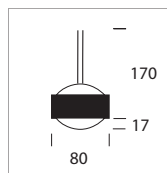

□ Chrom Teile/  
chrome parts  
■ Gepulverte Teile/  
powdered parts

**Puk Side Single**

LED **G**

Lumen: ~1.200

Kelvin: ~2.700

Watt: 2 x 8W

📏 : Ø 80mm X H 177mm

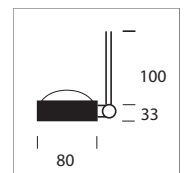

Farbe Color	Art.-Nr. Item-No.
chrome matt	2-38001-LED-MT-C
chrome	2-38002-LED-MT-D
white/chrome	2-3800-22-LED-MT-A
black/chrome	2-3800-02-LED-MT-B

Farbe Color	Art.-Nr. Item-No.
chrome matt	7-75001-MT-C
chrome	7-75002-MT-D
white/chrome	7-7500-22-MT-A
black/chrome	7-7500-02-MT-B

Farbe Color	Art.-Nr. Item-No.
chrome matt	2-0821-LED-MT-C
chrome	2-0822-LED-MT-D
white/chrome	2-082-22-LED-MT-A
black/chrome	2-082-02-LED-MT-B

Bei den Puk Leuchten werden zu dem Leuchtenkopf die Gläser/Linsen und optional die Farbfilter separat dazubestellt. Artikelnummern entnehmen Sie bitte der Equipment-Tabelle auf der Einklappseite.

With the Puk lamps, the glasses, lenses and optional the color filters are ordered separately. Please check the equipment list on the fold-in page for item numbers.



Mini Track Puk Turn & Puk Long One



**PUK SIDE TWIN**  
UP & DOWNLIGHT



**PUK LONG ONE**  
DOWNLIGHT



**PUK MAXX LONG ONE**  
DOWNLIGHT

Adapterfarben: für chrommatt = silber, für chrom = chrom, für weiß/chrom = weiß und für schwarz/chrom = schwarz  
Adapter Color: for chrom matt = silver, for chrome = chrome, for white/chrome = white and for black/chrome = black

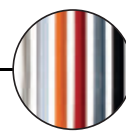

Optional Kabelvarianten.  
Optional cable.



- Chrom Teile/  
chrome parts
- Gepulverte Teile/  
powdered parts

**Puk Side Twin**

LED **G**

Lumen: ~2.400

Kelvin: ~2.700

Watt: 4 x 8W

: Ø 80mm X H 177mm

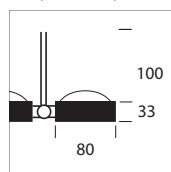

- Chrom Teile/  
chrome parts
- Gepulverte Teile/  
powdered parts

**Puk Long One**

LED **G**

Lumen: ~600

Kelvin: ~2.700

Watt: 1 x 8W

: Ø 80mm X H ~1.300mm

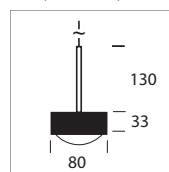

- Chrom Teile/  
chrome parts
- Gepulverte Teile/  
powdered parts

**Puk Maxx Long One**

LED **G**

Lumen: ~900

Kelvin: ~2.700

Watt: 1 x 12W

: Ø 120mm X H ~1.300mm

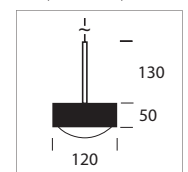

Farbe Color	Art.-Nr. Item-No.
chrome matt	2-0841-LED-MT-C
chrome	2-0842-LED-MT-D
white/chrome	2-084-22-LED-MT-A
black/chrome	2-084-02-LED-MT-B

Farbe Color	Art.-Nr. Item-No.
chrome matt	5-08001-1-LED-MT-C
chrome	5-08002-1-LED-MT-D
white/chrome	5-0800-22-1-LED-MT-A
black/chrome	5-0800-02-1-LED-MT-B

Farbe Color	Art.-Nr. Item-No.
chrome matt	5-38001-MT-C
chrome	5-38002-MT-D
white/chrome	5-3800-22-MT-A
black/chrome	5-3800-02-MT-B

Bei den Puk Leuchten werden zu dem Leuchtenkopf die Gläser/Linsen und optional die Farbfilter separat dazubestellt. Artikelnummern entnehmen Sie bitte der Equipment-Tabelle auf der Einklappseite.

With the Puk lamps, the glasses, lenses and optional the color filters are ordered separately. Please check the equipment list on the fold-in page for item numbers.

SYSTEM



**PUK DROP**  
UP & DOWNLIGHT



**PUK MAXX DROP**  
UP & DOWNLIGHT



**PUK FLEXLIGHT**  
UP & DOWNLIGHT

Adapterfarben: für chrommatt = silber, für chrom = chrom, für weiß/chrom = weiß und für schwarz/chrom = schwarz  
Adapter Color: for chrom matt = silver, for chrome = chrome, for white/chrome = white and for black/chrome = black



□ Chrom Teile/  
chrome parts  
■ Gepulverte Teile/  
powdered parts

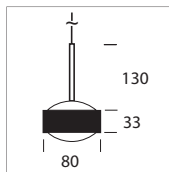

**Puk Drop**

LED **G**

Lumen: ~1.200

Kelvin: ~2.700

Watt: 2 x 8W

📏 : Ø 80mm X H ~1.300mm

□ Chrom Teile/  
chrome parts  
■ Gepulverte Teile/  
powdered parts

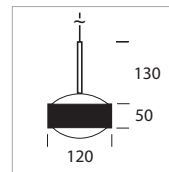

**Puk Maxx Drop**

LED **G**

Lumen: ~1.800

Kelvin: ~2.700

Watt: 2 x 12W

📏 : Ø 120mm X H ~1.300mm

□ Chrom Teile/  
chrome parts  
■ Gepulverte Teile/  
powdered parts

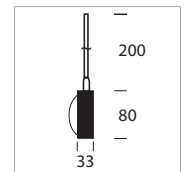

**Puk Flexlight**

LED **G**

Lumen: ~1.200

Kelvin: ~2.700

Watt: 2 x 8W

📏 : Ø 80mm X H 294mm

Farbe Color	Art.-Nr. Item-No.
chrome matt	5-06001-MT-C
chrome	5-06002-MT-D
white/chrome	5-0600-22-MT-A
black/chrome	5-0600-02-MT-B

Farbe Color	Art.-Nr. Item-No.
chrome matt	5-36001-MT-C
chrome	5-36002-MT-D
white/chrome	5-3600-22-MT-A
black/chrome	5-3600-02-MT-B

Farbe Color	Art.-Nr. Item-No.
chrome	20114-LED-MT-D

Bei den Puk Leuchten werden zu dem Leuchtenkopf die Gläser/Linsen und optional die Farbfilter separat dazubestellt. Artikelnummern entnehmen Sie bitte der Equipment-Tabelle auf der Einklappe.

With the Puk lamps, the glasses, lenses and optional the color filters are ordered separately. Please check the equipment list on the fold-in page for item numbers.



**LOOK AT ME**  
DOWNLIGHT



**PELA**  
ALL-ROUND LIGHT



**PELA QUADRO**  
ALL-ROUND LIGHT

Adapterfarben: für chrommatt = silber, für chrom = chrom, für weiß = weiß und für schwarz = schwarz  
 Adapter Color: for chrom matt = silver, for chrome = chrome, for white = white and for black = black

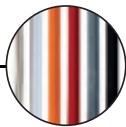

Optional Kabelvarianten.  
Optional cable.

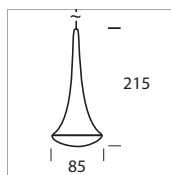

**Look at me**

LED **G**  
 Lumen: ~600  
 Kelvin: ~2.700  
 Watt: 1 x 8W  
 : Ø 85mm X H ~1.300mm

Farbe Color	Art.-Nr. Item-No.
chrome matt	5-911-1-MT-C
chrome	5-911-2-MT-D
white matt	5-911-22-MT-A
black matt	5-911-02-MT-B
lens clear	2-9126
lens frosted	2-9126-S

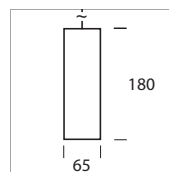

**Pela**

E27: ohne Leuchtmittel/without bulb  
 Lumen: leuchtmittelabhängig  
according to bulb  
 Kelvin: leuchtmittelabhängig  
according to bulb  
 Watt: max. 1 x 42W optional LED Retrofit  
 : Ø 65mm X H ~1.300mm

Farbe Color	Art.-Nr. Item-No.
chrome	5-07651-MT-D

**Pela Quadro**

E27: ohne Leuchtmittel/without bulb  
 Lumen: leuchtmittelabhängig  
according to bulb  
 Kelvin: leuchtmittelabhängig  
according to bulb  
 Watt: max. 1 x 42W optional LED Retrofit  
 : B 65mm X H ~1.300mm

Farbe Color	Art.-Nr. Item-No.
chrome	5-08651-MT-D

SYSTEM



**SUN CEILING**  
DOWNLIGHT



**SUN CEILING**  
DOWNLIGHT



**SUN SWING**  
DOWNLIGHT

Adapterfarben: für chrommatt = silber, für chrom = chrom, für weiß/chrom = weiß und für schwarz/chrom = schwarz  
Adapter Color: for chrom matt = silver, for chrome = chrome, for white/chrome = white and for black/chrome = black



□ Chrom Teile/  
chrome parts  
■ Gepulverte Teile/  
powdered parts

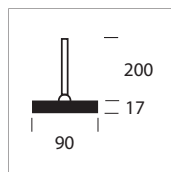

**Sun Ceiling**

LED **G**

Lumen: ~920

Kelvin: ~2.700

Watt: 1 x 8W

: Ø 90mm X H 231mm



□ Chrom Teile/  
chrome parts  
■ Gepulverte Teile/  
powdered parts

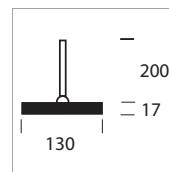

**Sun Ceiling**

LED **G**

Lumen: ~1.300

Kelvin: ~2.700

Watt: 1 x 12W

: Ø 130mm X H 231mm

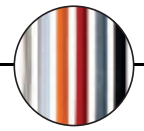
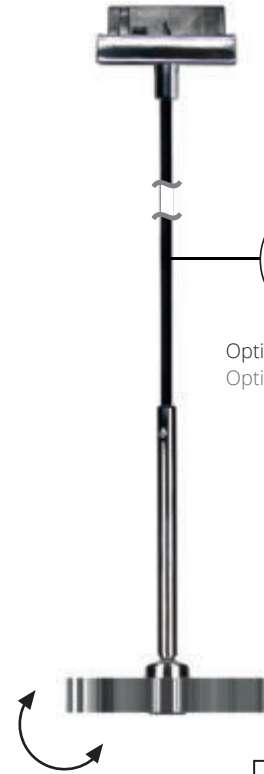

Optional Kabelvarianten.  
Optional cable.



□ Chrom Teile/  
chrome parts  
■ Gepulverte Teile/  
powdered parts

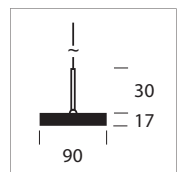

**Sun Swing**

LED **G**

Lumen: ~920

Kelvin: ~2.700

Watt: 1 x 8W

: Ø 90mm X H ~1.300mm

Farbe Color	Art.-Nr. Item-No.
chrome matt	7-3269011-MT-C
chrome	7-3269012-MT-D
white/chrome	7-32690122-MT-A
black/chrome	7-32690102-MT-B

Farbe Color	Art.-Nr. Item-No.
chrome matt	7-32613011-MT-C
chrome	7-32613012-MT-D
white/chrome	7-326130122-MT-A
black/chrome	7-326130102-MT-B

Farbe Color	Art.-Nr. Item-No.
chrome matt	7-3289011-MT-C
chrome	7-3289012-MT-D
white/chrome	7-32890122-MT-A
black/chrome	7-32890102-MT-B





**SUN SWING**  
DOWNLIGHT



**IGLO**  
ALL-ROUND LIGHT



**INDIA**  
ALL-ROUND LIGHT

Adapterfarben: für chrommatt = silber, für chrom = chrom, für weiß/chrom = weiß und für schwarz/chrom = schwarz  
 Adapter Color: for chrom matt = silver, for chrome = chrome, for white/chrome = white and for black/chrome = black



□ Chrom Teile/  
chrome parts  
■ Gepulverte Teile/  
powdered parts

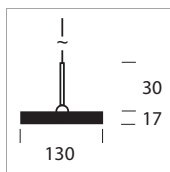

**Sun Swing**

LED **G**

Lumen: ~1.300

Kelvin: ~2.700

Watt: 1 x 12W

∅ 130mm X H ~1.300mm

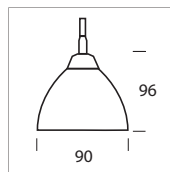

**Iglo**

G9: ohne Leuchtmittel/without bulb

Lumen: leuchtmittelabhängig  
according to bulb

Kelvin: leuchtmittelabhängig  
according to bulb

Watt: max. 1 x 33W

∅ 90mm X H 160mm

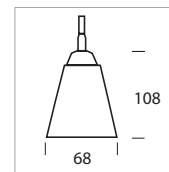

**India**

G9: ohne Leuchtmittel/without bulb

Lumen: leuchtmittelabhängig  
according to bulb

Kelvin: leuchtmittelabhängig  
according to bulb

Watt: max. 1 x 33W

∅ 68mm X H 172mm

Farbe Color	Art.-Nr. Item-No.
chrome matt	7-32813011-MT-C
chrome	7-32813012-MT-D
white/chrome	7-3281301-22-MT-A
black/chrome	7-3281301-02-MT-B

Farbe Color	Art.-Nr. Item-No.
chrome	0101-MT-D

Farbe Color	Art.-Nr. Item-No.
chrome	0102-MT-D

SYSTEM



**PISA**  
ALL-ROUND LIGHT



**Pisa**

G9: ohne Leuchtmittel/without bulb  
Lumen: leuchtmittelabhängig/according to bulb  
Kelvin: leuchtmittelabhängig/according to bulb  
Watt: max. 1 x 33W  
📏 : Ø 38mm X H 162mm

Farbe Color	Art.-Nr. Item-No.
chrome	0103-MT-D



**PISA DOUBLE**  
ALL-ROUND LIGHT

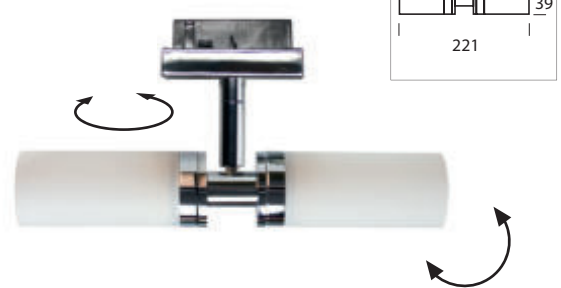

**Pisa Double**

G9: ohne Leuchtmittel/without bulb  
Lumen: leuchtmittelabhängig/according to bulb  
Kelvin: leuchtmittelabhängig/according to bulb  
Watt: max. 2 x 33W  
📏 : Ø 38mm X B 200mm x H 64mm

Farbe Color	Art.-Nr. Item-No.
chrome	0130-MT-D



**BULB**  
ALL-ROUND LIGHT

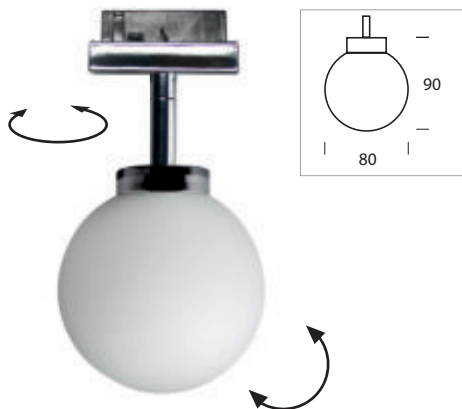

**Bulb**

G9: ohne Leuchtmittel/without bulb  
Lumen: leuchtmittelabhängig/according to bulb  
Kelvin: leuchtmittelabhängig/according to bulb  
Watt: max. 1 x 33W  
📏 : Ø 80mm X H 154mm

Farbe Color	Art.-Nr. Item-No.
chrome	0132-MT-D



**RIO**  
DOWNLIGHT



**Rio**

GU10: ohne Leuchtmittel/without bulb  
Lumen: leuchtmittelabhängig/according to bulb  
Kelvin: leuchtmittelabhängig/according to bulb  
Watt: max. 1 x 4W LED Retrofit  
📏 : Ø 65mm X H 144mm

Farbe Color	Art.-Nr. Item-No.
chrome	0117-MT-D



**NEO TRACK**  
DOWNLIGHT



**NEO SWING**  
DOWNLIGHT



**NEO FLEX**  
DOWNLIGHT

Adapterfarbe: für aluminium = chrom und schwarz  
Adapter Color: for aluminium = chrome and black

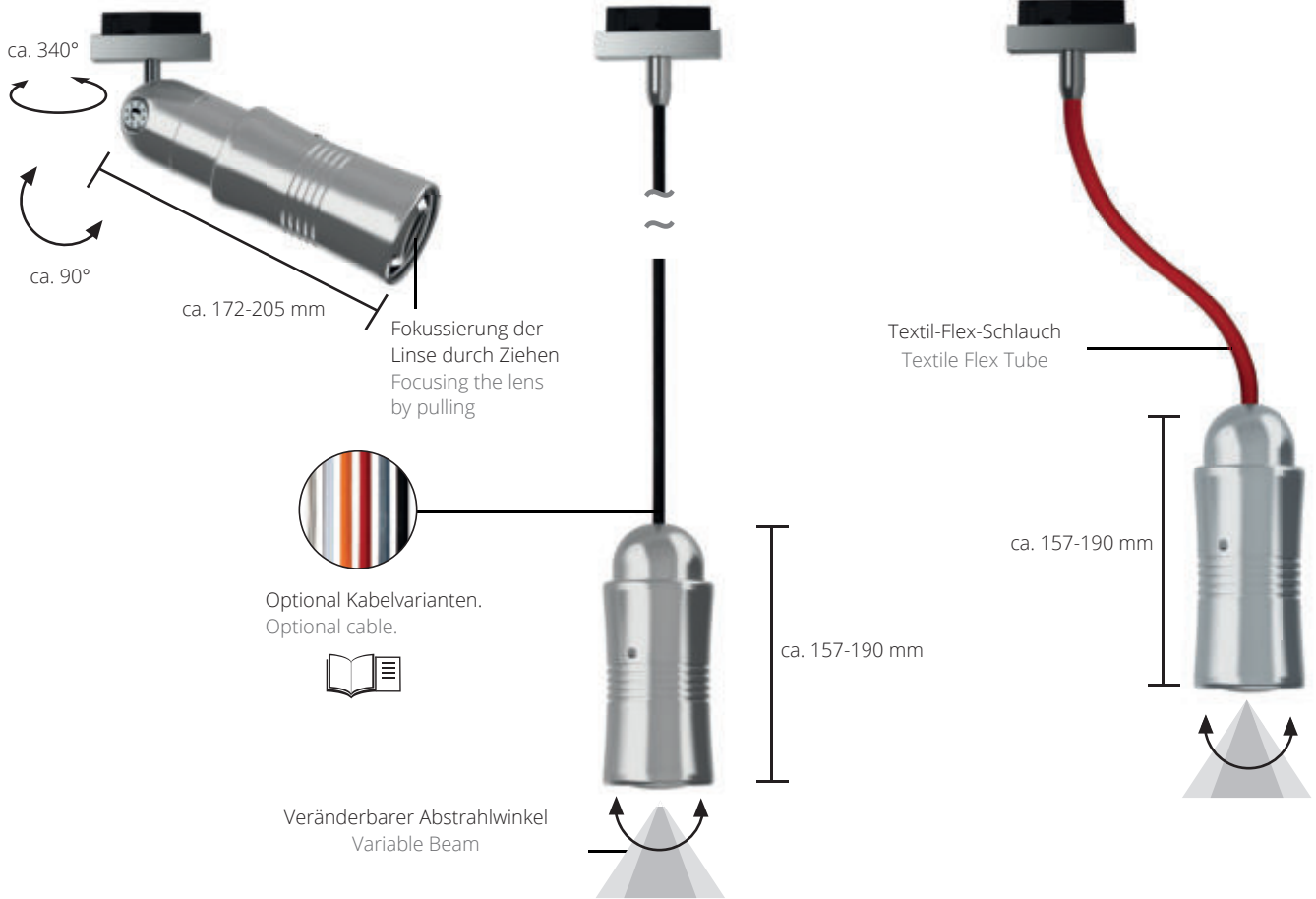

**Neo Track**

LED **G**  
Lumen: ~710  
Kelvin: ~2.700  
Watt: 1 x 10W  
: Ø 65mm X L 172-205mm

**Neo Pendant**

LED **G**  
Lumen: ~710  
Kelvin: ~2.700  
Watt: 1 x 10W  
: Ø 65mm X H ~1.300mm

**Neo Flex**

LED **G**  
Lumen: ~710  
Kelvin: ~2.700  
Watt: 1 x 10W  
: Ø 65mm X H min. 511mm

Farbe Color	Art.-Nr. Item-No.
aluminium	16-02-MT-D

Farbe Color	Art.-Nr. Item-No.
aluminium	16-05-MT-D

Flexarm L	Art.-Nr. Item-No.
300mm red	16-06303-MT-D
300mm black	16-06306-MT-D
300mm grey	16-0630X-MT-D

SYSTEM